

BASES



You can choose any base shape among 6 types below to meet your application.
The 15,24,36,45,54 & 60 steps are available for all the bases.

FINISH : Unichrome plating



I - type

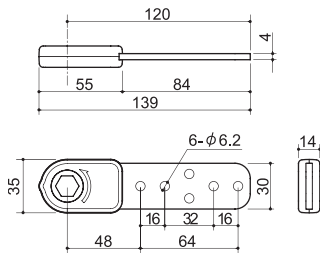

S - type

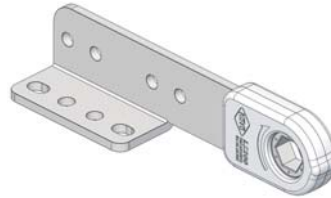
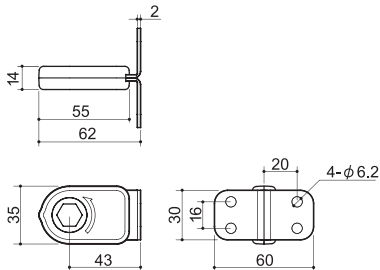

L - type

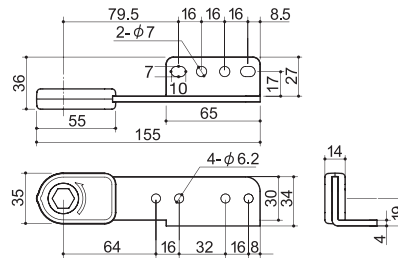

IC - type

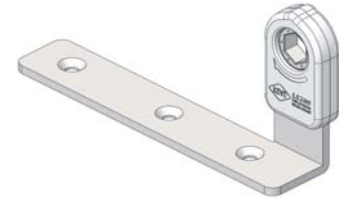
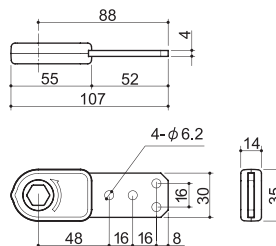

Z - type

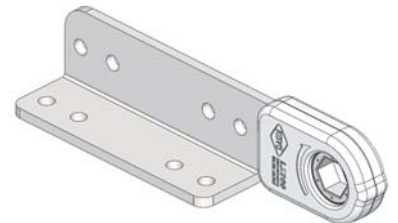
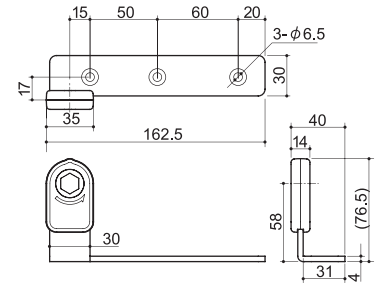

T - type

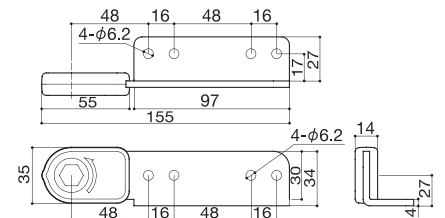

S

ARMS



Various shape of arms would help furnish your furniture.
You can enhance your options usable to meet the wood frame shape furnished.

No.10

FINISH : Chrome plating

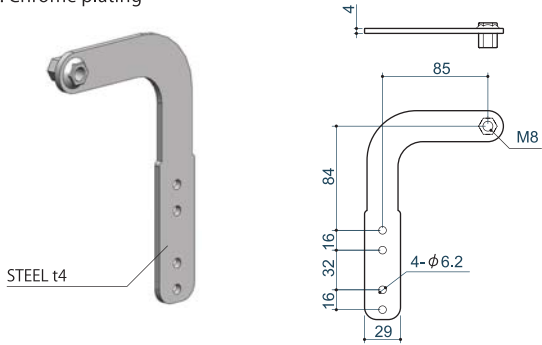

No.11

FINISH : Unichrome plating

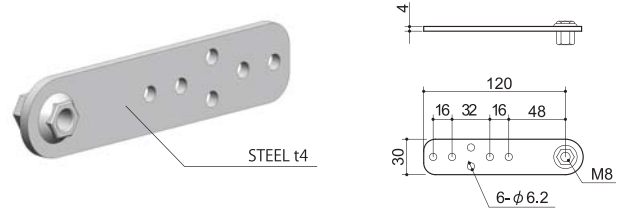

No.30A

FINISH : Chrome plating

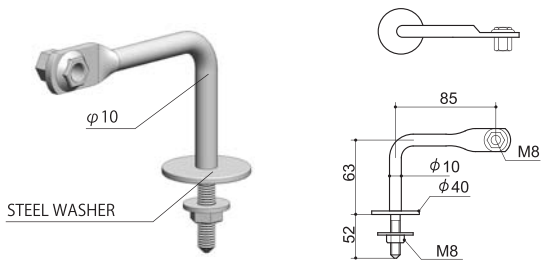

No.15

FINISH : Unichrome plating

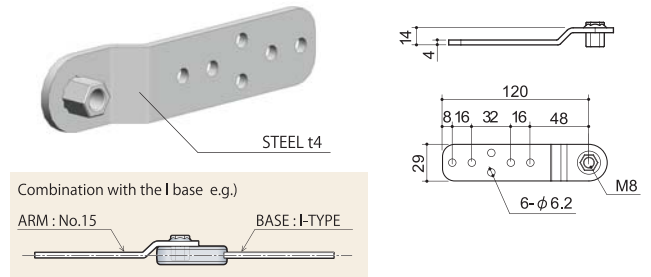

No.31 ~33AJ

FINISH : Chrome plating

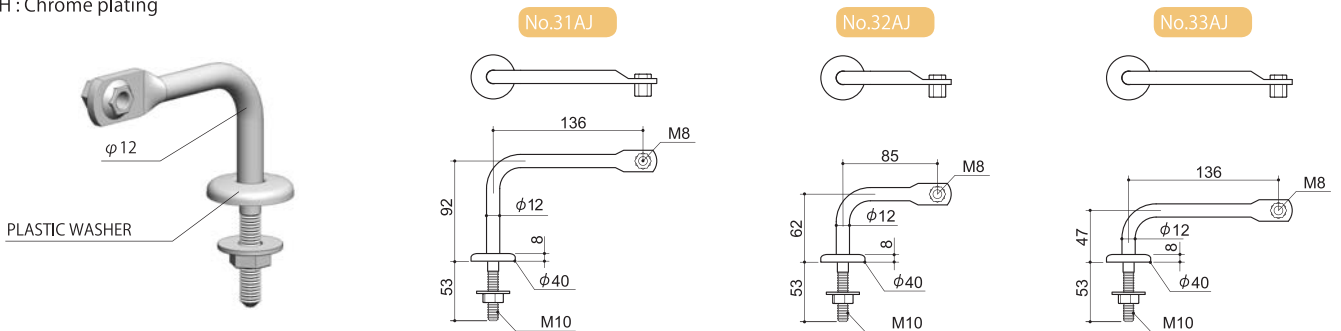

No.31 ~33AF

FINISH : Chrome plating

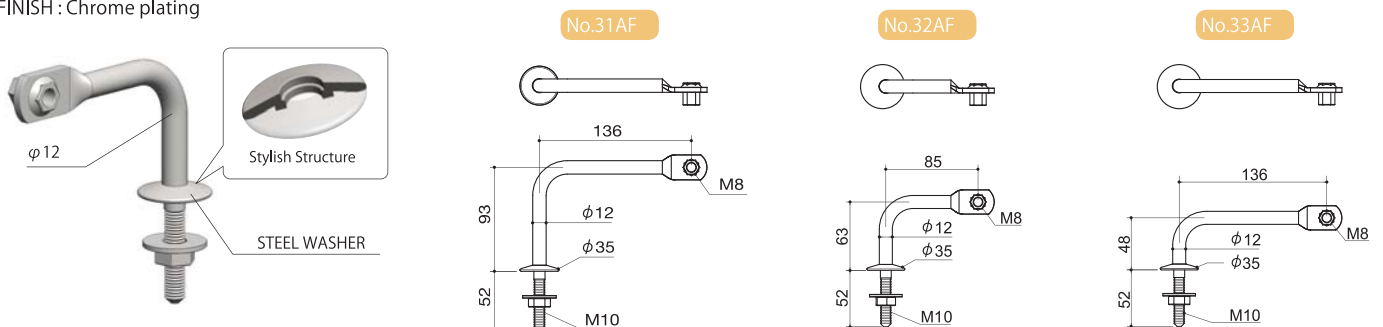

No.31 ~33BJ

FINISH : Chrome plating

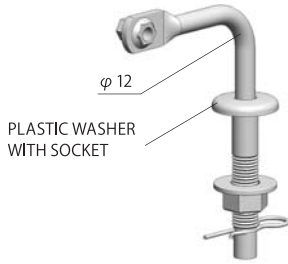

No.31BJ

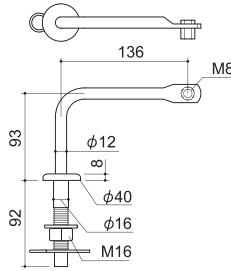

No.32BJ

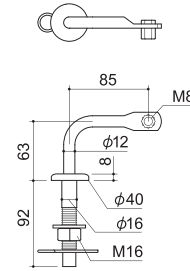

No.33BJ

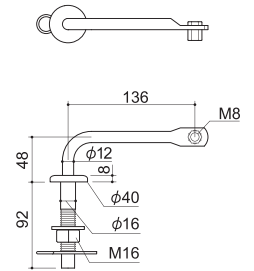

No.31 ~33B

FINISH : Chrome plating

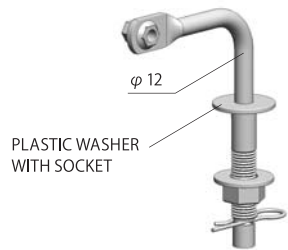

No.31B

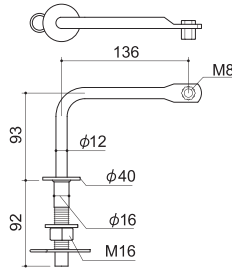

No.32B

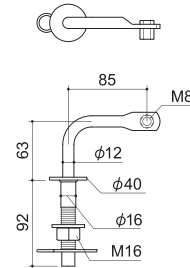

No.33B

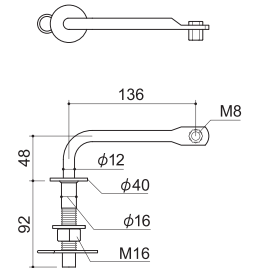

No.31 ~33G

FINISH : Chrome plating

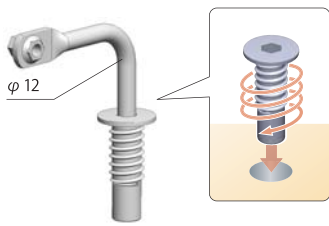

No.31G

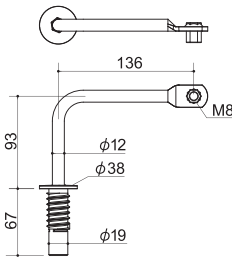

No.32G

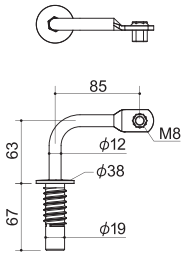

No.33G

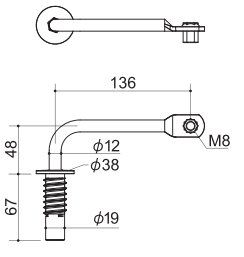

HEAD REST TYPE

頭

LS200-MP72I-R52DJ-P150

