

LS200-α

Innovative Free-Lock Mechanism

NEW

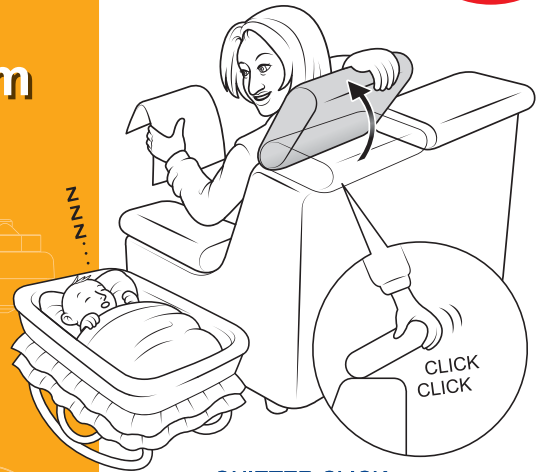
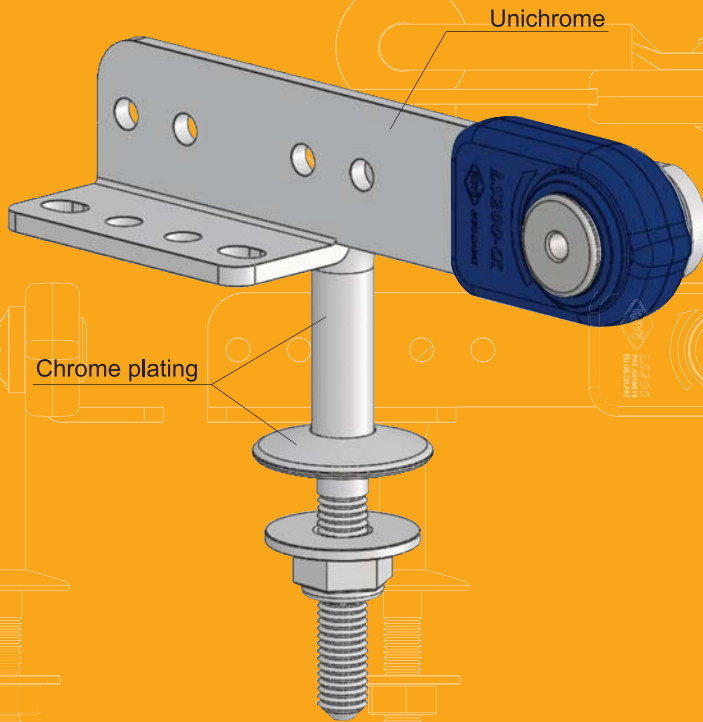

QUIETER CLICK

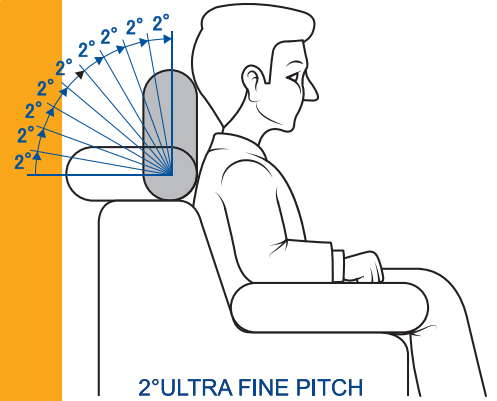

2° ULTRA FINE PITCH GEAR FITS YOU BETTER

LS200-a-90L-32AF

DURABILITY: 200N·m

Quick & Easy!



EASIER ANGLE ADJUSTMENT POSSIBLE IN BETWEEN WITHOUT FLATTENING THE ARMREST

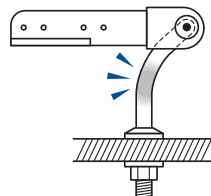

STILL FUNCTIONAL EVEN AFTER ANY POSSIBLE DEFORMATION IN USE

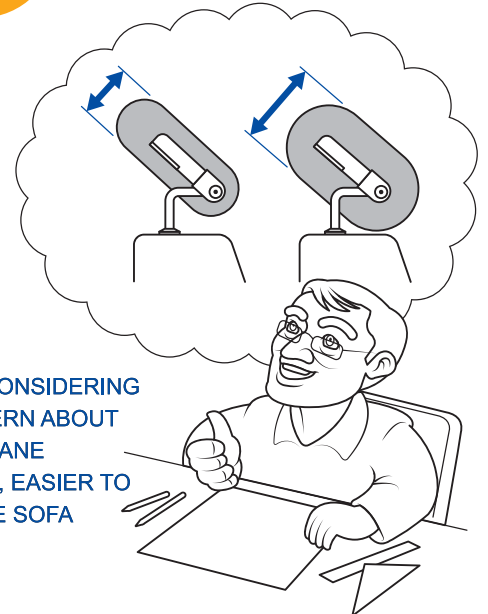

WITHOUT CONSIDERING ANY CONCERN ABOUT THE URETHANE THICKNESS, EASIER TO DESIGN THE SOFA

LS200- α gear

KOYO Corporation
<http://www.koyogear.com>
 Email: info@koyoeng.co.jp



DRAWING

LS200- α -90L-32AF

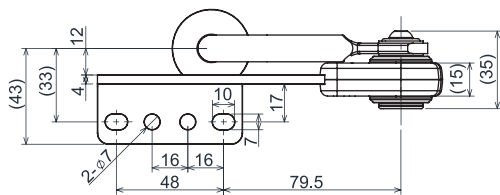

※NOTE:
 LS200 SERIES STANDARD MODELS
 HAVE DIFFERENT DIMENSIONS.

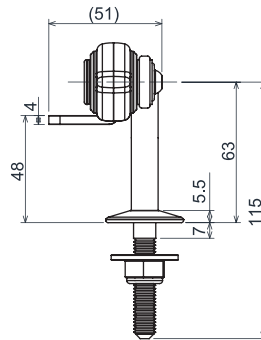
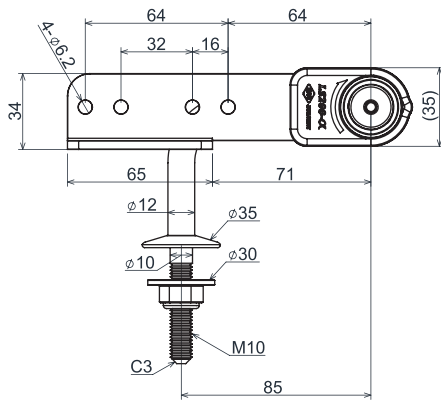
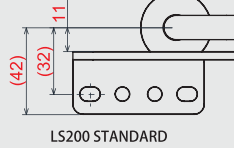

GEAR STEPS

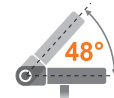

24 STEPS



36 STEPS

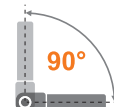

45 STEPS



54 STEPS



60 STEPS

ARM VARIATIONS

AF type

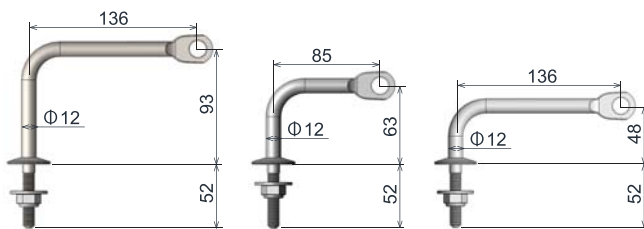

31AF

32AF

33AF

B-type & G-type also available

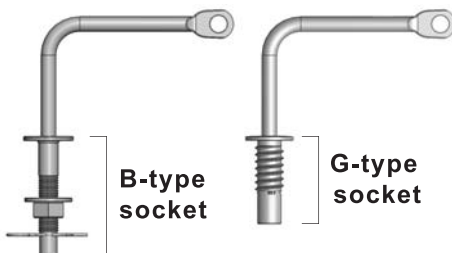

B-type socket

G-type socket

BASE VARIATIONS

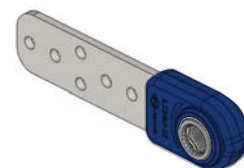

I-type

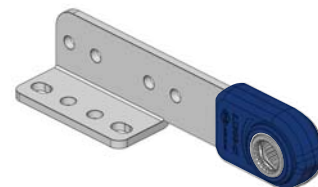

L-type