

IS Gears

International Standard Gears



Heart & Technology

Image Only

IS Gears

Back ground

Due to the recent focus on functional sofas (Head rest & Arm rest), the requirements for those parts have been gradually increasing.

In order to meet those requests, we have been utilized our original "fine gear" structure and finally developed our IS gears successfully.

Main Features

1. Ideal 6° degrees fine pitch reclining angle
2. Silent click gear
3. The most durable 210N·m(17% increased compared with our conventional model)
4. Secured by design: Complete protection for the mechanism inside
5. Easier to assemble with a universal design
6. Developed only for wooden frame sofa's reclining function

	IS gear
Thickness	14mm
Durability	210N·m
Pitch	6°
Cosmetics	Complete Symmetry
OEM	Possible for different motion patterns/steps



IS gear
PAT.EU,CHINA,USA,JAPAN

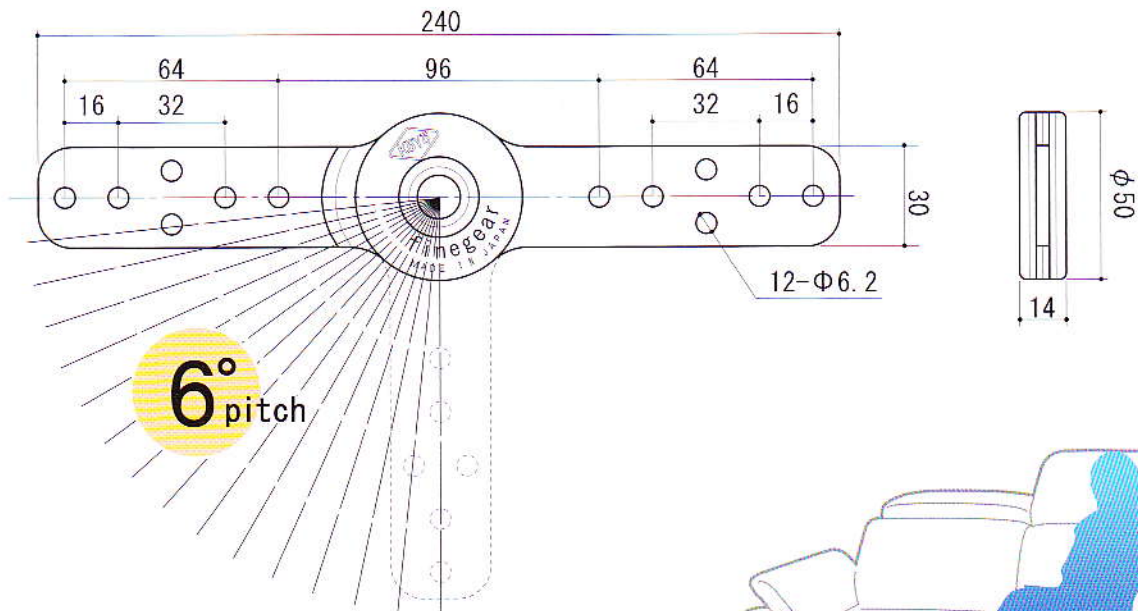

for armrests

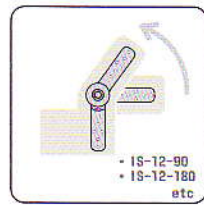
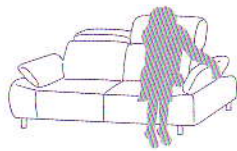

for headrests

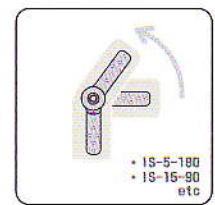
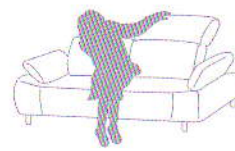

for footrests

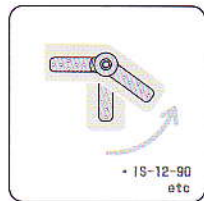
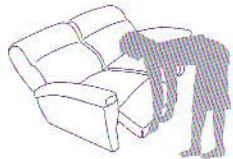

for backrests

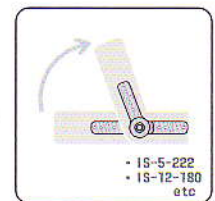
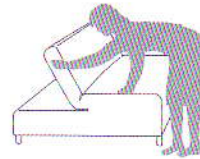

5steps

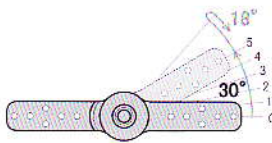

IS-5-180
zero position=180°
end position= 210°

9steps

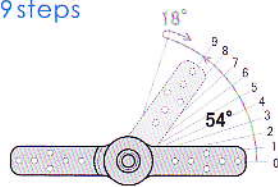

IS-9-180
zero position=180°
end position= 232°

12steps

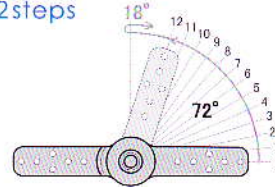

IS-12-180
zero position=180°
end position= 252°

15steps

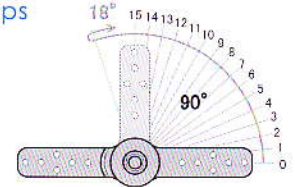

IS-15-180
zero position=180°
end position= 270°

5steps

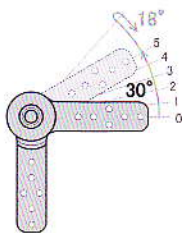

IS-5-90
zero position=90°
end position= 120°

9steps

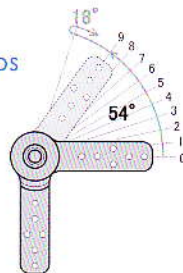

IS-9-90
zero position=90°
end position= 126°

12steps

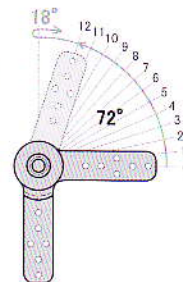

IS-12-90
zero position=90°
end position= 144°

15steps

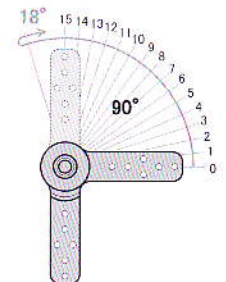

IS-15-90
zero position=90°
end position= 162°

IS-5-132

zero position=132°
end position= 162°

5steps

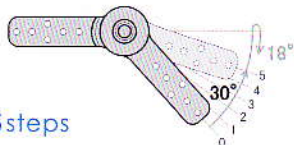

IS-15-162

zero position=162°
end position= 252°

15steps

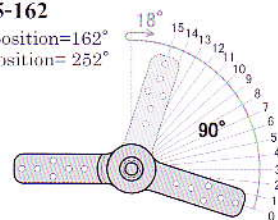

IS-15-72

zero position=72°
end position= 162°

15steps

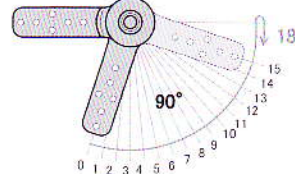

IS-5-222

zero position=222°
end position= 252°

5steps

